

A new *in situ* cell for XAFS investigations

Holger Huwe and Michael Fröba*

Institute of Inorganic and Analytical Chemistry, Justus Liebig University Giessen, Heinrich-Buff-Ring 58, D-35392 Giessen, Germany.

E-mail: michael.froeba@anorg.chemie.uni-giessen.de

A new *in situ* cell for X-ray absorption spectroscopic investigations has been designed and tested. In contrast to existing cells, it is able to reach temperatures as high as 1250 K and can record X-ray absorption spectra in transmission and fluorescence modes. Furthermore, the cell is equipped with a new sample-holder system which allows an easy sample changing. All components are commercial and are simple to build. The cell is light and easy to handle, and can be used under reducing or oxidizing conditions which makes it suitable for performing reduction and oxidation investigations as demanded, *e.g.* in heterogeneous catalysis experiments. The cell was tested on the reduction of haematite.

Keywords: X-ray absorption spectroscopy; *in situ* cells; instrumentation; *in situ* XAFS.

1. Introduction

Interest in *in situ* experiments using X-ray absorption spectroscopy has been on the increase in recent years. The possibility of performing time- and temperature-resolved experiments has led to the design of different *in situ* cells for several approaches (Jentoft *et al.*, 2004; Ressler, 2003; Pettiti *et al.*, 1999; van Bokhoven *et al.*, 1999; Kampers *et al.*, 1989; Dent *et al.*, 1995; Zhang *et al.*, 1991). Most of them are used in the study of catalysts (Ressler *et al.*, 2003; Wienold *et al.*, 2003).

Here we report on the construction of a new *in situ* cell with a wide range of applications. The cell is of a simple design – the use of special and complex manufactured parts has been avoided. All of the parts used are not expensive and can be assembled in a common machine shop. In addition, the cell is light, easy to handle and robust.

The sample-holder system was constructed for the housing of sample pills. It allows a very simple sample changing combined with a reproducible setting with respect to the sample position. The chosen material and design benefit the temperature distribution as well as gas changes during the measurements.

The most important advantage of the cell is the combination of several features known from other cells (*e.g.* high temperature without fluorescence yield detection). The cell makes *in situ* XAFS studies possible for elements with an absorption of X-rays over a wide range. Simultaneous detection of transmission and fluorescence yield is possible. During experiments the temperature can be varied from room temperature up to 1250 K. A wide choice of gas mixtures for reduction and oxidation cycles is conceivable.

2. *In situ* cell

The cell consists of three main parts: (i) the reaction room, which accommodates (ii) the sample holder, and (iii) the gas and temperature control system.

The main part of the reaction room is a T-shaped quartz tube (25 mm in diameter), around which are wrapped a heating wire and copper cooling tubes. An S-shape winding of the heating wire allows a

nearly uniform temperature distribution at the sample position. In order to attach the wire and to gain a better temperature assignment the heating wire was built of oven cement. The area of constant temperature was estimated to be an area 7.5 mm × 7.5 mm around the sample position.

The ends of the tube are closed using brass flanges, which consist of an end cap, a spacer, a gasket and a screw holder. The end caps are bored 25 mm in diameter and equipped with an epoxy-sealed Kapton polyimide foil (of thickness 50 µm) for the X-ray beam to pass through. Changing the window material (*e.g.* to beryllium) is possible if necessary. Each of the two spacers is equipped with a tube for gas inlet or outlet. In addition, one spacer carries and fixes the thermocouple (Pt10%Rh/Pt), which is embedded in a ceramic tube, positioned such that its end is close to the sample position and at 2 mm from the quartz wall. The set-up is shown schematically in Fig. 1, and Figs. 2, 3 and 4 show different views of the entire cell. Important cell parameters are listed in Table 1.

First investigations show that it is possible to reduce the size of the entire cell by more than a half without restricting any of the features described above. This might be useful for space-restricted beamlines or for increasing the transmission and fluorescence yields.

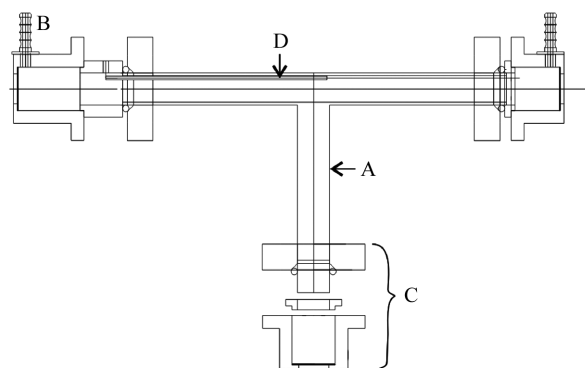

Figure 1

Construction drawing of the *in situ* cell. A: quartz tube; B: reaction gas intake or release flow socket; C: flange consisting of end cap, spacer, gasket and screw holder; D: thermocouple.

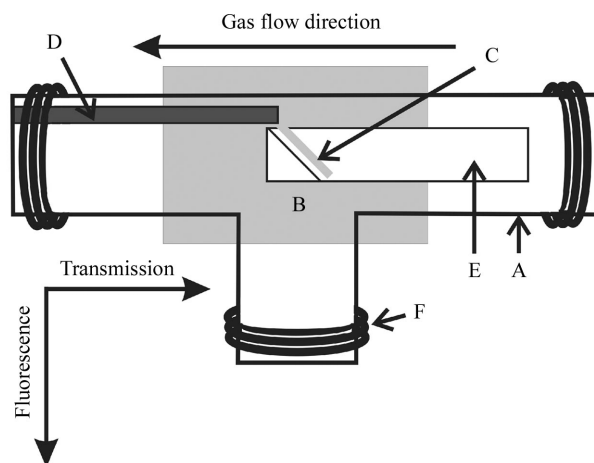

Figure 2

Schematic drawing of the *in situ* cell. A: T-shaped quartz tube; B: heating area (shaded); C: sample position; D: thermocouple; E: sample holder; F: water-cooling unit of the fluorescence arm.

Table 1
Cell parameters.

Parameter	Value
Dimensions (length × width × height)	400 × 300 × 150 mm
Sample–transmission window distance	190 mm
Sample–fluorescence window distance	100 mm
Temperature range	Room temperature to 1250 K
Heating power	540 W (maximum 10 A, 50 V)
Heating resistor	5.4 Ω
Thermocouple	Pt10%Rh/Pt
Constant-temperature length	15 mm

The design and construction of this cell offers some technical and safety advantages, *e.g.* the structural separation between the electric (especially the heating area) and the water-cooling parts. In addition, the sample and the experimental gas are physically separated from the electric and heating wires.

The sample holder consists of a specially cut quartz tube as shown in Fig. 5. The sample, pressed as a boron nitride pellet (maximum diameter 16 mm), is mounted at an angle of 45° to the direction of the cut quartz tube. The quartz tube is specially cut to avoid any shielding

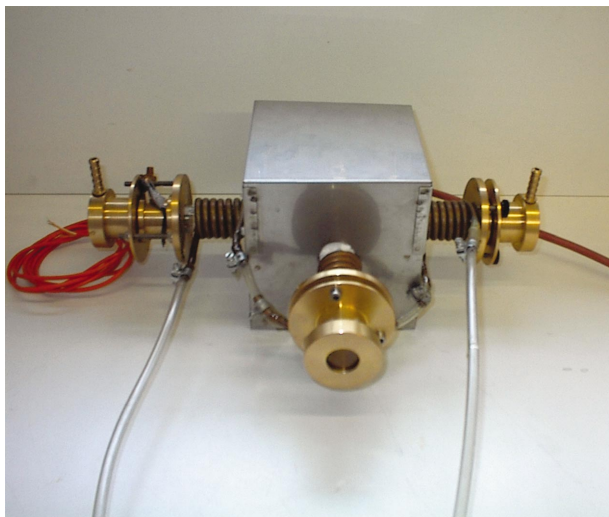

Figure 3
The entire cell viewed from the side.

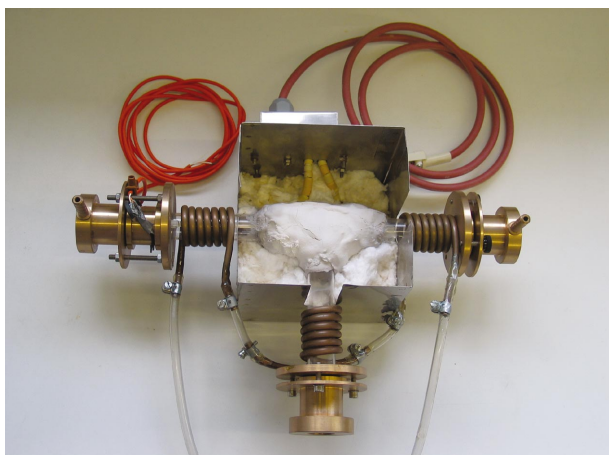

Figure 4
The entire cell viewed from the top, with the top of the box and the thermal insulation removed.

of the fluorescence radiation. The reaction gas impinges on the sample after flowing through the tube. This makes it possible to switch gases while ignoring the gas mixture in the fluorescence arm of the cell.

In order to change the sample, one of the end caps has to be removed. The sample holder is then inserted into the furnace up to the desired position (marked on the outside) and the end cap is then replaced.

The *in situ* cell operates with a programmable temperature controller (Eurotherm 815S) with the possibility of performing heating ramps. The temperature allocations during these ramps are shown in Fig. 6. The temperature curves are recorded under real conditions (*i.e.* at the sample position with a nitrogen gas flow of 5 cm³ min⁻¹, water cooling and aligned sample holder). It can be clearly seen that after a self-optimization procedure of the controller the differences between the desired and the real temperature are marginal over a large temperature range.

3. EXAFS measurements

First tests were carried out at the HASYLAB@DESY EXAFSII beamline E4. The cell was tested in an experiment on the reduction of bulk haematite.

For the *in situ* measurements, bulk haematite was pressed into a boron nitride pellet of diameter 10 mm and thickness 0.5 mm. The reaction gas was 5% hydrogen in nitrogen with a flow rate of 5 cm³ min⁻¹ and a heating rate of 2° min⁻¹. XAFS spectra were

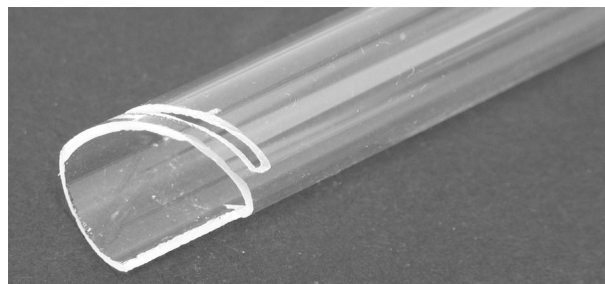

Figure 5
Quartz sample holder.

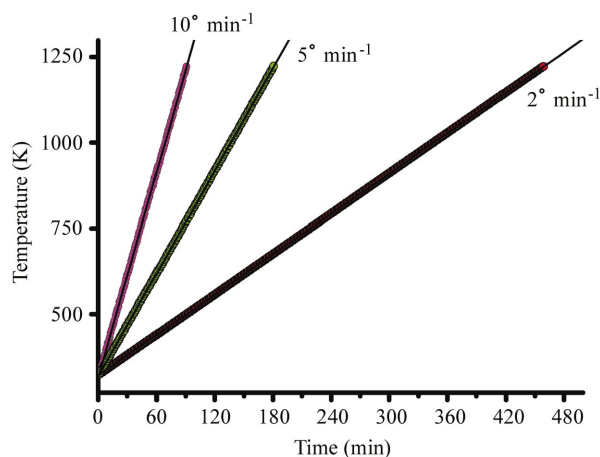

Figure 6
Temperature allocation for three heating ramps, collected after previous self-optimization of the controller/cell system. The temperature curves were recorded under real conditions (*i.e.* with nitrogen gas flow, water cooling and aligned sample holder) at the point of the sample position.

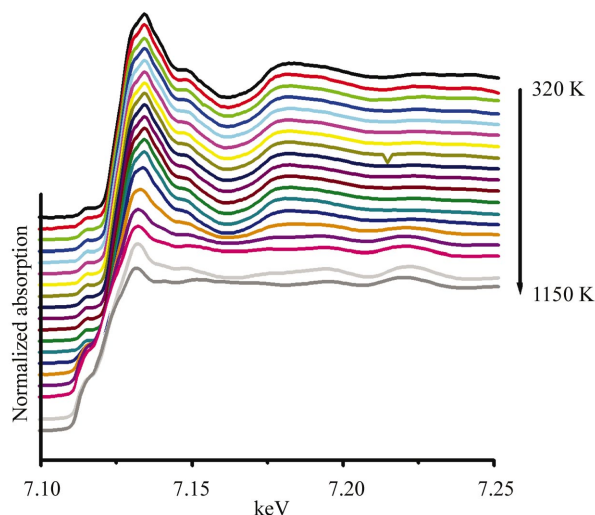

Figure 7
In situ XANES spectra of the reduction of bulk haematite (transmission).

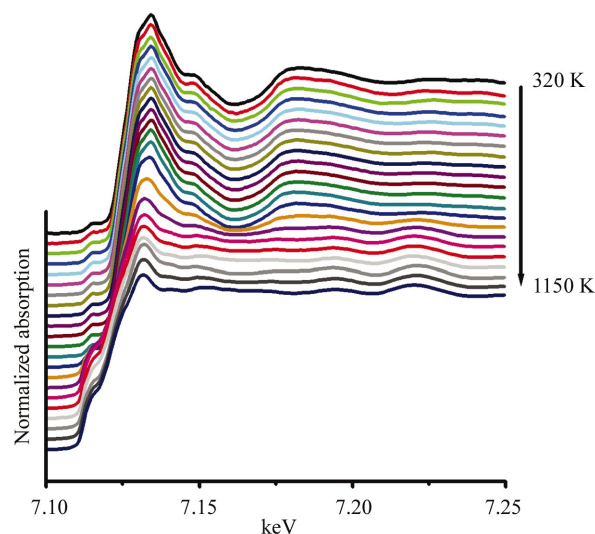

Figure 8
In situ XANES spectra of the reduction of bulk haematite (fluorescence).

recorded in a temperature range from 320 K up to 1150 K. It should be mentioned that the spectra were not collected in equidistant temperature steps. This is due to the different temperature ranges where a reduction to the respective iron oxides appears.

Figs. 7 and 8 show the corresponding energy-calibrated normalized background-corrected XANES spectra recorded at the Fe *K* edge in transmission and fluorescence mode, respectively. For both, a temperature-dependent change of the pre-edge peak is observed, combined with modifications in the white line and in the EXAFS oscillations. Evaluation of the spectra using principle component analysis shows the appearance of four different phases for both the transmission and fluorescence spectra series. These phases are α -Fe₂O₃ (<570 K), Fe₃O₄ (570 K), FeO (640 K) and Fe⁰ (>1050 K), as expected (Webb & Orr, 1997). The proportions of the different iron phases in the transmission and fluorescence series are the same at respective temperatures. All these results demonstrate the usage of the *in situ* cell.

4. Conclusions

A new XAFS *in situ* cell has been designed, constructed and applied. It is able to reach temperatures up to 1250 K and can record X-ray absorption spectra in transmission and fluorescence modes. The sample holder allows for simple sample changing. The cell was successfully used in the reduction of haematite.

Financial support by the Fonds der Chemischen Industrie is gratefully acknowledged. We would like to thank HASY-LAB@DESY for allocating beam time and the HASYLAB staff for supporting us. Thanks to Ralf Sack (head of our machine shop) for building the cell.

References

- Bokhoven, J. A. van, van der Eerden, A. M. J., Smith, A. D. & Koningsberger, D. C. (1999). *J. Synchrotron Rad.* **6**, 201–203.
- Dent, A. J., Greaves, G. N., Roberts, M. A., Sankar, G., Wright, P. A., Jones, R. H., Sheehy, M., Madill, D., Catlow, C. R. A., Thomas, J. M. & Rayment, T. (1995). *Nucl. Instrum. Methods Phys. Res. B*, **97**, 20–22.
- Jentoft, R. E., Hahn, A. H. P., oft, F. C. & Ressler, T. (2004). *Phys. Scr.* Accepted.
- Kampers, F. W. H., Maas, T. M. J., van Groundelle, J., Brinkgreve, P. & Koningsberger, D. C. (1989). *Rev. Sci. Instrum.* **60**, 2635–2638.
- Pettiti, I., Gazzoli, D., Inversi, M., Valigi, M., De Rossi, S., Ferraris, G., Porta, P. & Colonna, S. (1999). *J. Synchrotron Rad.* **6**, 1120–1124.
- Ressler, T. (2003). *Anal. Bioanal. Chem.* **376**, 584–593.
- Ressler, T., Wienold, J., Jentoft, R. E. & Girgsdies, F. (2003). *Eur. J. Inorg. Chem.* **2**, 301–312.
- Webb, P. A. & Orr, C. (1997). *Analytical Methods in Fine Particle Technology*, p. 265. Norcross, GA: Micromeritics Instruments. (ISBN 0-9656783-0-X.)
- Wienold, J., Timpe, O. & Ressler, T. (2003). *Chem. Eur. J.* **9**, 6007–6017.
- Zhang, Z., Chen, H. & Sachtler, W. M. H. (1991). *J. Chem. Soc. Faraday Trans.* **87**, 1413–1418.